

# JSB SOLAR

QUALITY THE FIRST  
REPUTATION THE IMPORTANCE  
MANAGEMENT THE BASIS  
SERVICE THE SINCERITY

<http://jinmeimetal.en.alibaba.com>



<http://www.wx-jsb.com>



无锡市金山北金属制品厂  
无锡金美金属材料有限公司  
无锡金苏科技有限公司

WUXI JIN SHANBEI METAL PRODUCTS FACTORY  
WUXI JINMEI METAL MATERIALS CO., LTD.  
WUXI JINSU TECHNOLOGY CO., LTD.

#### 无锡金山北金属制品厂

地址：无锡市北塘区江海西路990号智慧568大厦26楼  
电话：0510-83235668 传真：0510-83235998  
邮箱：acksolar@163.com jennyzhi@163.com  
<http://jinmeimetal.en.alibaba.com>  
<http://www.wx-jsb.com>

#### 金山北(天津)金属制品厂

地址：天津市金海道27号

#### 金山北(新疆)金属制品厂

地址：新疆昌吉州昌吉市三工镇永光路

#### Wuxi Jin Shanbei metal products factory

Address: 26th floor, ZhiHui 568 Building, No.990, Jianghai West Road,Wuxi City, Jiangsu Province.  
Tel/0510-83235668 Fax/0510-83235998  
Mailbox: acksolar@163.com jennyzhi@163.com  
<http://jinmeimetal.en.alibaba.com> <http://www.wx-jsb.com>

#### Jin shanbei (Tianjin) metal products factory

Address: No. 27, jinhai Rd, jinghai country, Tianjin City

#### Jin shanbei(Sinkiang) metal products factory

Address: Yongguang Rd, Sangong Town, Changji City, Sinkiang



SAVE THE POLAR, GO SOLAR!

# COMPANY



## 公司简介

无锡市金山北金属制品厂成立于2001年，公司总面积19700平方米，拥有全自动生产线20条，主要生产销售：型钢；带钢；Z型钢；C型钢；太阳能支架；焊管加工等，产品远销美国，意大利，印度，日本，为国外多项大型工程提供完善的配套服务，同时，国内新疆，内蒙古等地的国家重点发电项目，也采用了我公司的产品。经过多年的发展，公司已成为国内生产太阳能光伏支架最具规模的生产企业之一。旗下有三家子公司分别为：无锡金美金属材料有限公司，无锡金苏科技有限公司和金山北（天津）科技有限公司，为更好的服务客户，我公司在新疆和天津分别设立生产基地。

公司注重企业文化建设，不断创新，坚持以质量为中心，以技术为保证，以市场为先导，以同行业的口碑和信誉优势与国内外的众多厂家建立长期稳定和谐的合作关系，赢得广大客户的信赖。

公司近年业务量的增涨，业绩持续增强，厂地也持续扩建。

Wuxi Jin Shanbei metal products factory (hereinafter referred to as "JSB") is one of the world's largest manufactures and solution provider of solar racking system, which designs and manufactures high quality products for roof and ground areas. Whether for small or large-scale projects, tailor-made systems are delivered all the time. We work with companies in Tianjin & Sinkiang to offer our best services to meet your highly requirement.

We are proud of the fact that more than 5GW solar project from worldwide used JSB products: 1.5GW solar projects for overseas. With annual capacity of 2GW mounting structures.

JSB is well equipped to meet the growing solar energy needs of the market.

## COMPANY

### WUXI FACTORY



Wuxi Jin Shanbei Metal Products Factory



### TIANJIN FACTORY



Jin Shanbei (Tianjin) Metal Products Factory



### SINKIANG FACTORY



Jin Shanbei(Sinkiang) Metal Products Factory



We are not necessarily the best,  
But we must try to do better...

# HONOR

荣誉证书



We are not necessarily the best,  
But we must try to do better...

# PRODUCTION SHIPMENT

生产线 / PRODUCTION



## 目录 Contents

<b>01</b> 企业简介+厂区介绍 COMPANY PROFILE+FACTORY	01/02	<b>02</b> 公司荣誉+装箱出运+目录 HONOR+SHIPMENT+CATALOG	03/04
<b>03</b> 太阳能支架系统/单立柱 GROUND MOUNTED SOLUTIONS/ SINGLE POLE	05/06/07/08	<b>05</b> 屋顶系列 ROOFTOP SOLUTIONS	17/18/19/20
<b>04</b> 太阳能支架系统/双立柱 GROUND MOUNTED SOLUTIONS/ DUAL POLE	09/10/11/12/13/14/15/16		
<b>06</b> OEM OEM	21/22	<b>07</b> 产品案例 PROJECTS	23/24/25/26

装箱出运 / SHIPMENT

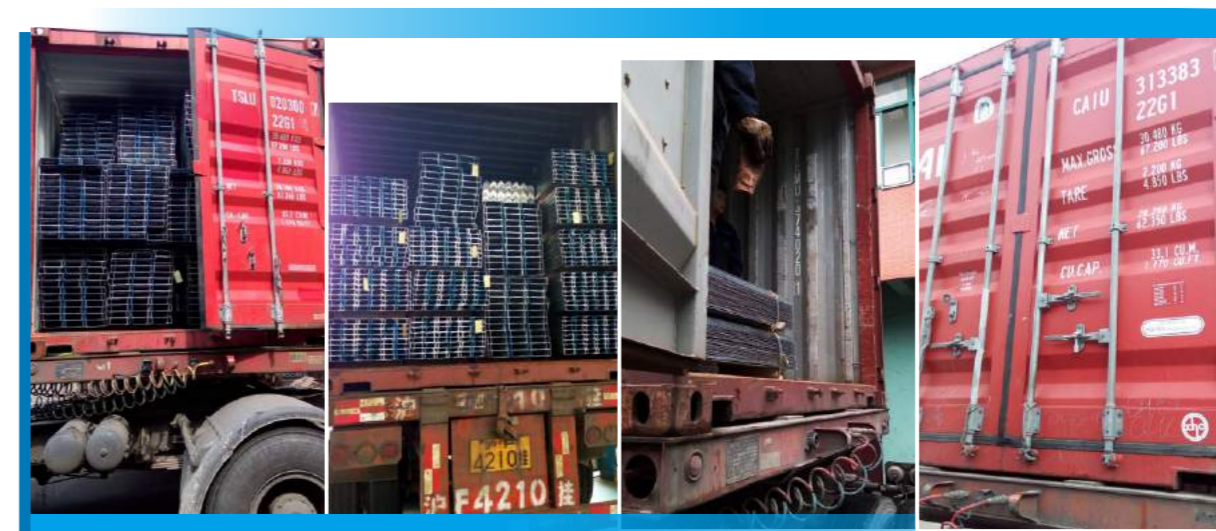



太阳能支架系统

# 单立柱 SINGLE POLE SOLUTIONS

## 单立柱 / 双撑

DOUBLE BRACE

JSB single pole structure specification as fast and easy installation , top hat profile of pile post can adjust to different terrain, special joints and adjustable connectors can suitable for related environmental challenges.

单立柱方案安装快速，结构简便，几字型钢的地桩可适用于不同的地形，特殊可调节的连接件，让此方案可应用在不同的环境下。

- Single pole solutions are high adaptability to different terrain and environment.
- High flexibility and fast installation
- NO need for land leveling
- Driving screw and screw piles are applicable
- Top quality materials and high durability
- No need welding at project site, fully adjustable for a perfectly installation

- 单立柱方案可适用于不同的地形和环境。
- 高灵活性，快速安装
- 无需平整土地
- 地桩和螺旋桩都适用
- 品质优良，寿命持久
- 工厂预安装程度高
- 无需现场焊接，便于安装

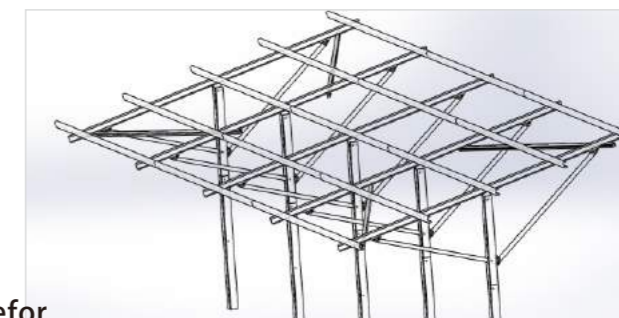



太阳能支架系统

# 单立柱 SINGLE POLE SOLUTIONS

## 单立柱 / 单撑 SINGLE BRACE

JSB single pole structure specification as fast and easy installation , top hat profile of pile post can adjust to different terrain, special joints and adjustable connectors can suitable for related environmental challenges.

单立柱方案安装快速，结构简便，几字型钢的地桩可适用于不同的地形，特殊可调节的连接件，让此方案可应用在不同的环境下。

- Single pole solutions are high adaptability to different terrain and environment.
- High flexibility and fast installation
- NO need for land leveling
- Driving screw and screw piles are applicable
- Top quality materials and high durability
- No need welding at project site, fully adjustable for a perfectly installation

- 单立柱方案可适用于不同的地形和环境。
- 高灵活性，快速安装
- 无需平整土地
- 地桩和螺旋桩都适用
- 品质优良，寿命持久
- 工厂预安装程度高
- 无需现场焊接，便于安装

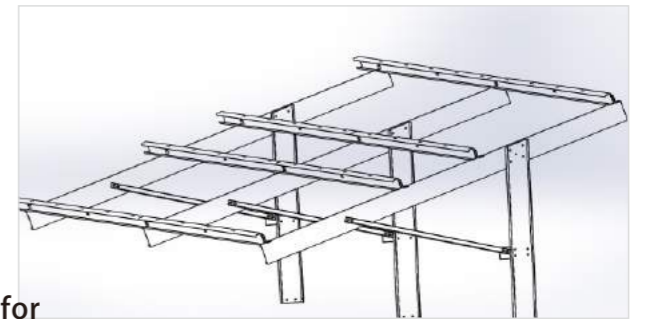

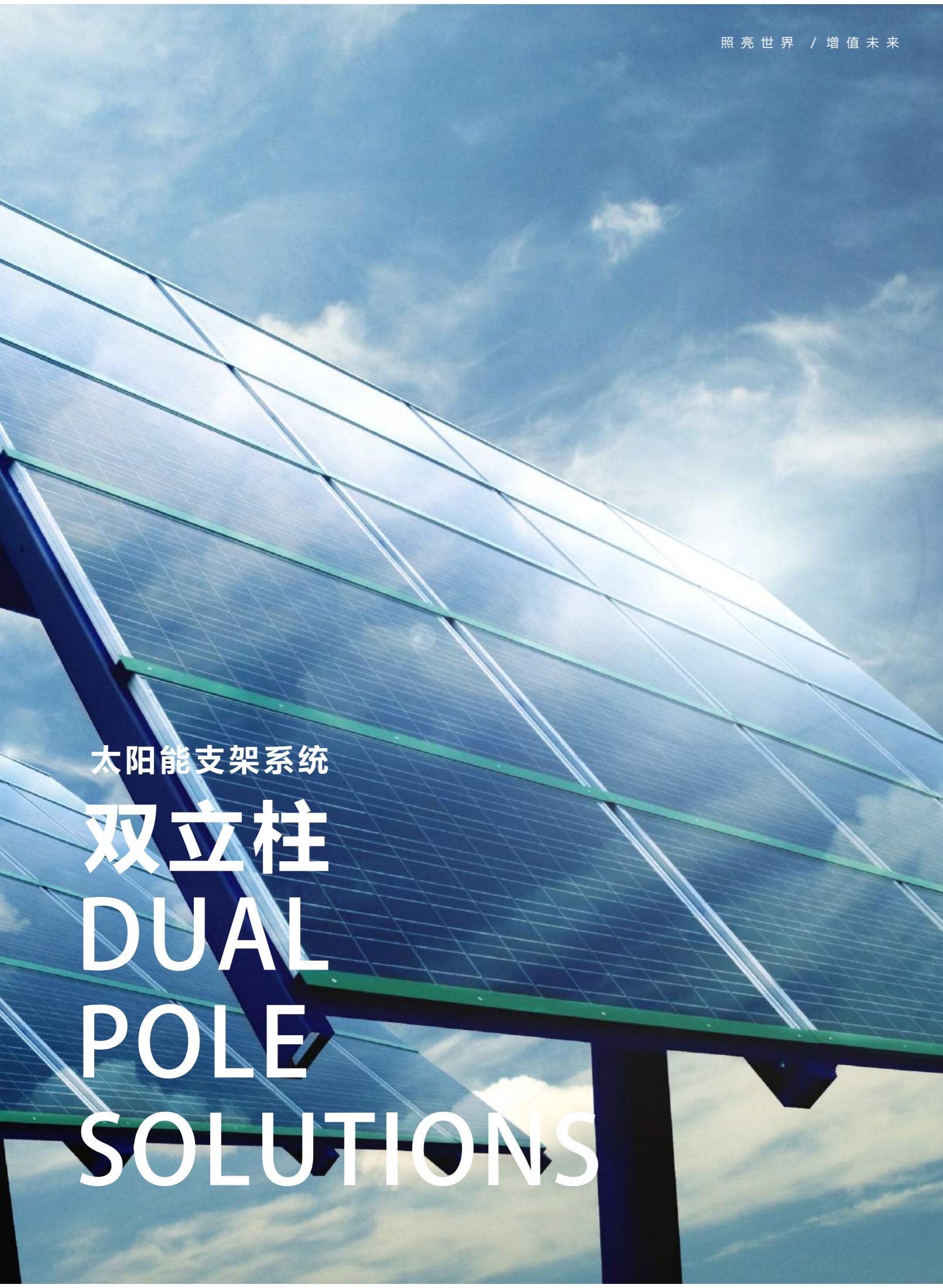

太阳能支架系统

双立柱

DUAL

POLE

SOLUTIONS

## 双立柱 / 水泥墩 / 单撑

BASEMENT WITH CONCRETED BASE

JSB Dual pole structures with their principles as resistance, quality and durability. Work as the most widely solutions for solar projects. JSB have produced over years of installation in very harsh Chinese desert and humidity, strong sand storm, wind gusts places also.

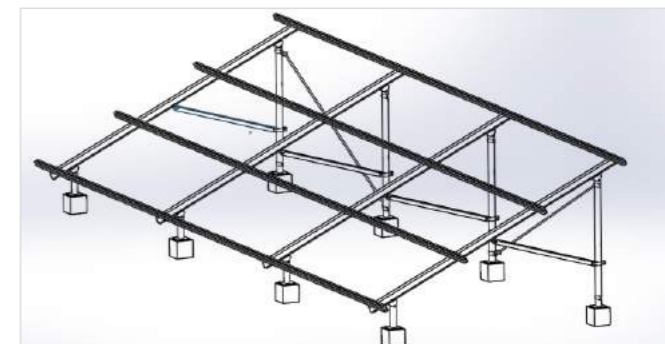

双立柱方案结构稳定，品质高，使用寿命长，是太阳能项目中使用最广泛的一种方案，多年来，JSB太阳能光伏支架广泛应用于沙漠，湿地，以及强风地带等的地形，特殊可调节的连接件，让此方案可应用在不同的环境下。

- Dual pole solutions have high structure stability
- Concrete foundation, driving screw and screw pile are all applicable
- Top quality materials and high durability
- High level of factory pre-assembly
- No need welding at project site, fully adjustable for a perfectly installation
- 双立柱结构稳定性好
- 混凝土基础、螺旋桩、桩基都可使用
- 品质优良，寿命持久
- 工厂可以进行预安装
- 无需现场焊接，便于安装





太阳能支架系统

双立柱

DUAL

POLE

SOLUTIONS

## 双立柱 / 水泥墩 / 双撑

BASEMENT WITH CONCRETED BASE

JSB Dual pole structures with their principles as resistance, quality and durability. Work as the most widely solutions for solar projects. JSB have produced over years of installation in very harsh Chinese desert and humidity, strong sand storm, wind gusts places also.



双立柱方案结构稳定，品质高，使用寿命长，是太阳能项目中使用最广泛的一种方案，多年来，JSB太阳能光伏支架广泛应用于沙漠，湿地，以及强风地带等的地形，特殊可调节的连接件，让此方案可应用在不同的环境下。

- Dual pole solutions have high structure stability
- Concrete foundation, driving screw and screw pile are all applicable
- Top quality materials and high durability
- High level of factory pre-assembly
- No need welding at project site, fully adjustable for a perfectly installation
- 双立柱结构稳定性好
- 混凝土基础、螺旋桩、桩基都可使用
- 品质优良，寿命持久
- 工厂可以进行预安装
- 无需现场焊接，便于安装



太阳能支架系统

# 双立柱 DUAL POLE SOLUTIONS

## 双立柱 / 螺旋桩 / 单撑

### BASEMENT WITH SCREW PILE

JSB Dual pole structures with their principles as resistance, quality and durability. Work as the most widely solutions for solar projects. JSB have produced over years of installation in very harsh Chinese desert and humidity, strong sand storm, wind gusts places also.

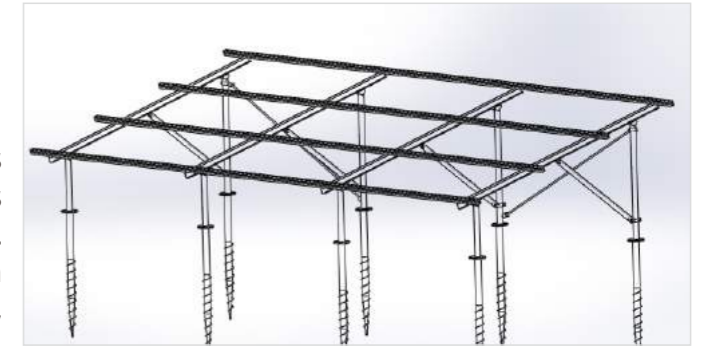

双立柱方案结构稳定，品质高，使用寿命长，是太阳能项目中使用最广泛的一种方案，多年来，JSB太阳能光伏支架广泛应用于沙漠，湿地，以及强风地带等的地形，特殊可调节的连接件，让此方案可应用在不同的环境下。

- Dual pole solutions have high structure stability
- Concrete foundation, driving screw and screw pile are all applicable
- Top quality materials and high durability
- High level of factory pre-assembly
- No need welding at project site, fully adjustable for a perfectly installation
- 双立柱结构稳定性好
- 混凝土基础、螺旋桩、桩基都可使用
- 品质优良，寿命持久
- 工厂可以进行预安装
- 无需现场焊接，便于安装





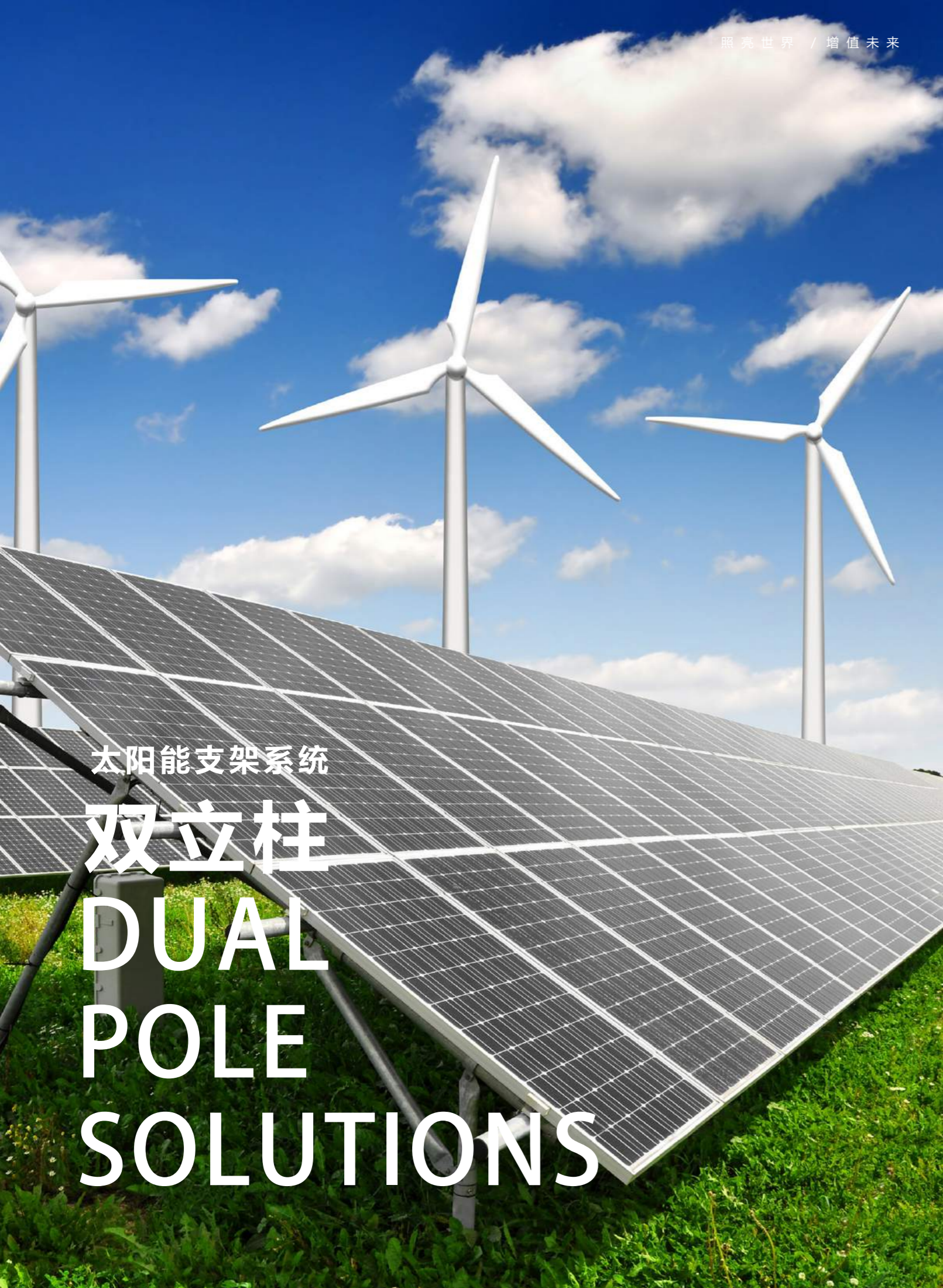

太阳能支架系统

双立柱

DUAL

POLE

SOLUTIONS

### 双立柱 / 螺旋桩 / 双撑

BASEMENT WITH SCREW PILE

JSB Dual pole structures with their principles as resistance, quality and durability. Work as the most widely solutions for solar projects. JSB have produced over years of installation in very harsh Chinese desert and humidity, strong sand storm, wind gusts places also.

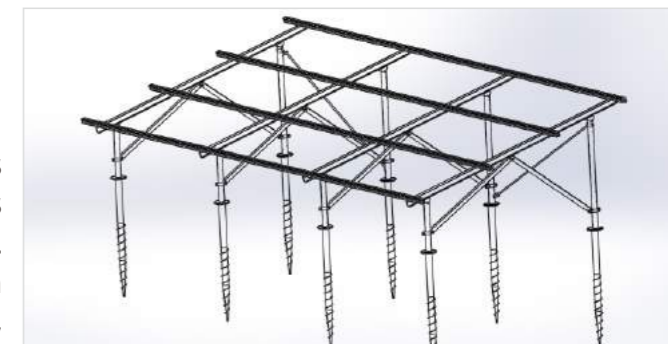

双立柱方案结构稳定，品质高，使用寿命长，是太阳能项目中使用最广泛的一种方案，多年来，JSB太阳能光伏支架广泛应用于沙漠，湿地，以及强风地带等的地形，特殊可调节的连接件，让此方案可应用在不同的环境下。

- Dual pole solutions have high structure stability
- Concrete foundation, driving screw and screw pile are all applicable
- Top quality materials and high durability
- High level of factory pre-assembly
- No need welding at project site, fully adjustable for a perfectly installation
- 双立柱结构稳定性好
- 混凝土基础、螺旋桩、桩基都可使用
- 品质优良，寿命持久
- 工厂可以进行预安装
- 无需现场焊接，便于安装





# 屋顶系列 ROOF TOP SOLUTIONS

## 屋顶项目 / 彩钢瓦屋顶 TILT ROOF SOLUTIONS

- Ballast system with preformed concrete foundation
- Triangle structure, high stability and reliability
- Preassembly shortened the installation time
- 压载系统由预制混凝土制成
- 三角结构，高稳定性和可靠性
- 组装快速，缩短安装时间

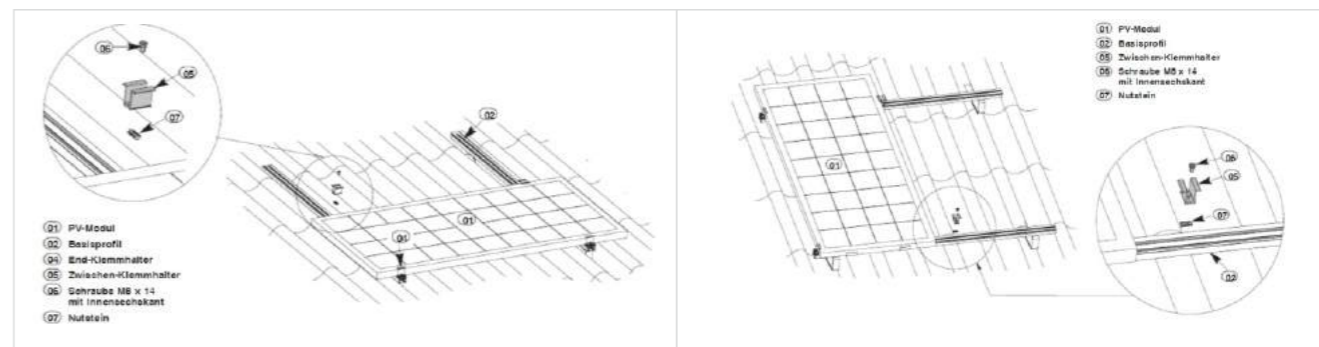

彩钢瓦支架竖向示意图

彩钢瓦支架横向示意图





# 屋顶系列 ROOF TOP SOLUTIONS

## 屋顶系列 / 平面屋顶 FLAT ROOF SOLUTIONS

- Parallel to roof solutions.
- Modules mounted on long rails, which make the system very robust and reliable.
- Fast installation.
- 平行于屋顶安装
- 组件直接安装在长导轨上，此方案为最具有性价比的方案
- 快速安装

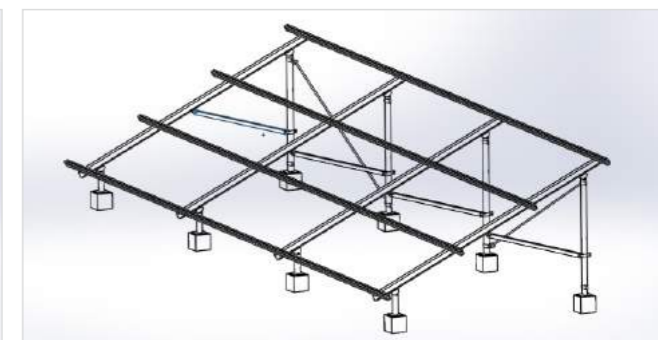

We are not necessarily the best,  
But we must try to do better...

# STEEL PROFILES

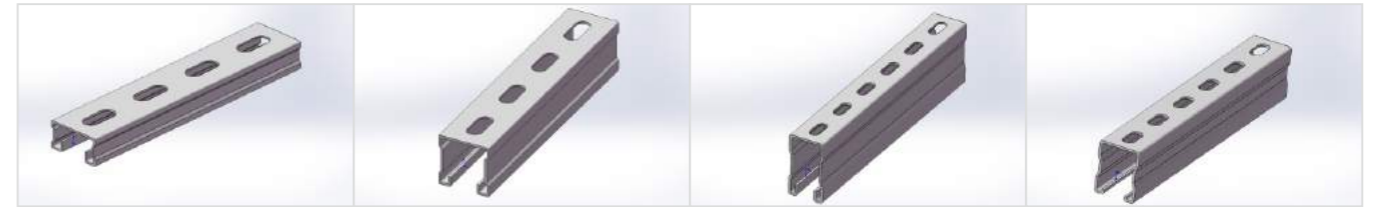

双内卷 / strut channel  
41x21x1.5

双内卷 / strut channel  
41x41x2

双内卷 / strut channel  
41x62x2.5

双内卷 / strut channel  
41x52x2.2

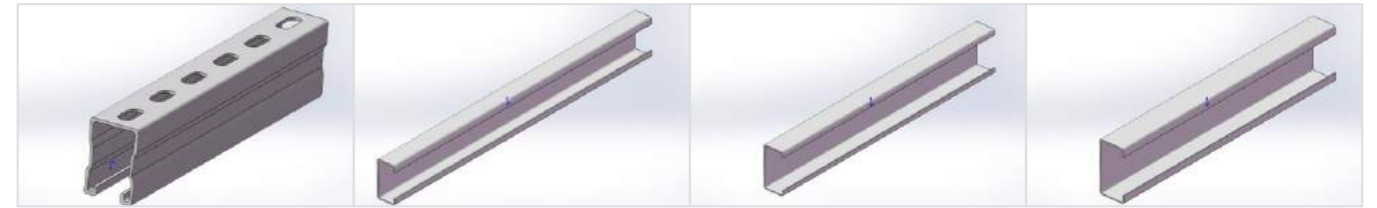

双内卷 / strut channel  
41x72x2.5

C型钢 / C profile  
60x30x10x2

C型钢 / C profile  
C80x40x10x2

C型钢 / C profile  
C100x50x15x2

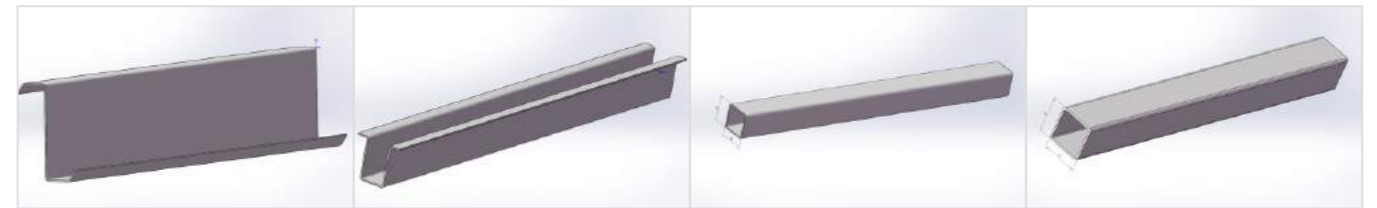

Z字形钢 / Z type profile

几字形钢 / Top hat profile

方管 / Square Tube  
40x40x2.5

矩形管 / Rectangular tube  
60x40x2.5

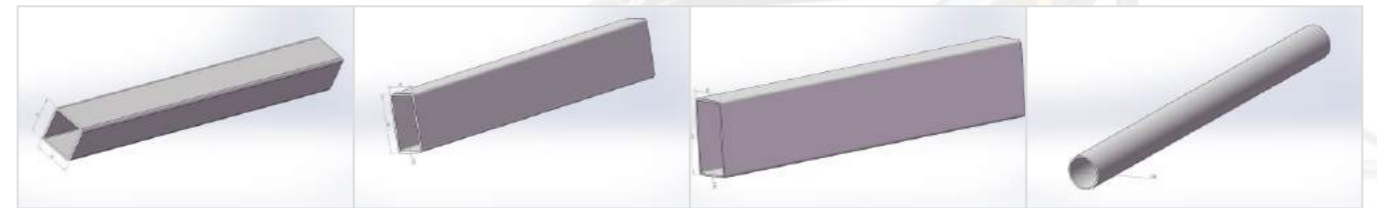

方管 / Square Tube  
60x60x2.5

矩形管 / Rectangular tube  
80x40x2.5

矩形管 / Rectangular tube  
100x50x2.5

圆管 / Circular tube  
60x2.5

# OEM



# JSB ADVANTAGES

## 公司生产能力 / Powerful Production Capacity

For three production bases of JSB SOLAR, annual production capacity can reach 2GW. With 5GW solar projects from worldwide used JSB products, we have gained huge manufacturing experience and overcome designing and installation challenges in variety of environments. Even after projects commissioned, our customers worldwide can rely on JSB and our comprehensive range of services.

公司拥有无锡、天津、新疆三大生产基地，年产能逾2GW，产品覆盖印度、日本、泰国、意大利等国家，累计发货量超5GW，公司拥有强大的制造力，完善的设计，并且有效的应对各种环境下的产品安装，即使是委托的项目。公司以全方位的服务态度，取得了全球客户的信赖与支持。



项目地 **Project sites:** Shanxi  
容量 **Volume:** 20MW  
时间 **Time:** 2016.6



项目地 **Project sites:** Wuhan  
容量 **Volume:** 30MW  
时间 **Time:** 2015.5



项目地 **Project sites:** Sinkiang  
容量 **Volume:** 30MW  
时间 **Time:** 2015.4



项目地 **Project sites:** Ningxia  
容量 **Volume:** 83MW  
时间 **Time:** 2015.7~2015.9



项目地 **Project sites:** Yunnan  
容量 **Volume:** 50MW  
时间 **Time:** 2015.10

# JSB ADVANTAGES

## 优秀的运输系统 / Excellent Available Transportation System

Wuxi is near to Shanghai port, Tianjin is near to Tianjin port, these two production bases can very easy to meet oversea customers' shipping port demanding. Also with Sinkiang production base, the domestic customers can have their goods and some shortages in very short time. Nearby available shipment eliminates the costs of transportation, breakage and packaging.

公司位于无锡和天津的生产基地，临近上海及天津港，满足海外客户对运输的要求，公司位于新疆的生产基地，使得国内部分客户缩短运输的时间。就近运输可避免运输途中产品包装的破损，及由此产生的费用。



项目地 **Project sites:** Dongying  
容量 **Volume:** 15MW  
时间 **Time:** 2015.4



项目地 **Project sites:** Gansu  
容量 **Volume:** 50MW  
时间 **Time:** 2015.10



项目地 **Project sites:** Shandong  
容量 **Volume:** 20MW  
时间 **Time:** 2016.4



项目地 **Project sites:** Henan  
容量 **Volume:** 50MW  
时间 **Time:** 2016.4



项目地 **Project sites:** Sinkiang  
容量 **Volume:** 80MW  
时间 **Time:** 2016.3~2016.6

# JSB ADVANTAGES

## 可靠性 / Reliability

As a specialist for solar mounting solutions, JSB always have standards for reliability. For continuous new solutions to meet customers' needs and guarantee the utmost reliability of each product we make. Our structures are designed to last for more than 25 years even in most of the extreme weather conditions like blizzards, high winds, hail and coastal sea spray.

作为解决太阳能安装方案的专家，公司一直坚持标准的可靠性，公司不断创新，以满足客户对不同方案安装的需求，公司拥有超过25年的结构设计经验，即使在最极端的气候，如暴风雪、强风、冰雹和沿海气候等，公司依然保证所生产的产品具有最大的可靠性。



项目地 **Project sites:**Hubei  
容量 **Volume:** 5MW  
时间 **Time:** 2016.3



项目地 **Project sites:**Japan  
容量 **Volume:** 67MW  
时间 **Time:** 2015.5



项目地 **Project sites:**Japan  
容量 **Volume:** 65MW  
时间 **Time:** 2015.3



项目地 **Project sites:**Gansu  
容量 **Volume:** 60MW  
时间 **Time:** 2015.9



项目地 **Project sites:**India  
容量 **Volume:** 90MW  
时间 **Time:** 2015.9~2015.12

# JSB ADVANTAGES

## 质量控制 / Quality Control

Our solar mounting structures are manufactured with fine production lines in accordance with stringent quality process. The compliance we deliver is ensured through one of the most advanced quality control programs ever implemented by a solar mounting structure provider.

公司拥有完善的生产线，通过严格的质量控制，生产最具保障的太阳能支架。作为一个太阳能支架供应商，公司交付的所有合格产品，拥有最先进的生产技术，最严厉的质量控制。



项目地 **Project sites:**India  
容量 **Volume:** 50MW  
时间 **Time:** 2016.1



项目地 **Project sites:**India  
容量 **Volume:** 40MW  
时间 **Time:** 2016.3



项目地 **Project sites:**Japan  
容量 **Volume:** 2MW  
时间 **Time:** 2016.1



项目地 **Project sites:**UK  
容量 **Volume:** 15MW  
时间 **Time:** 2015.4



项目地 **Project sites:**Mexico  
容量 **Volume:** 1.5MW  
时间 **Time:** 2015.12